

FFC CABLE

FFC 排线

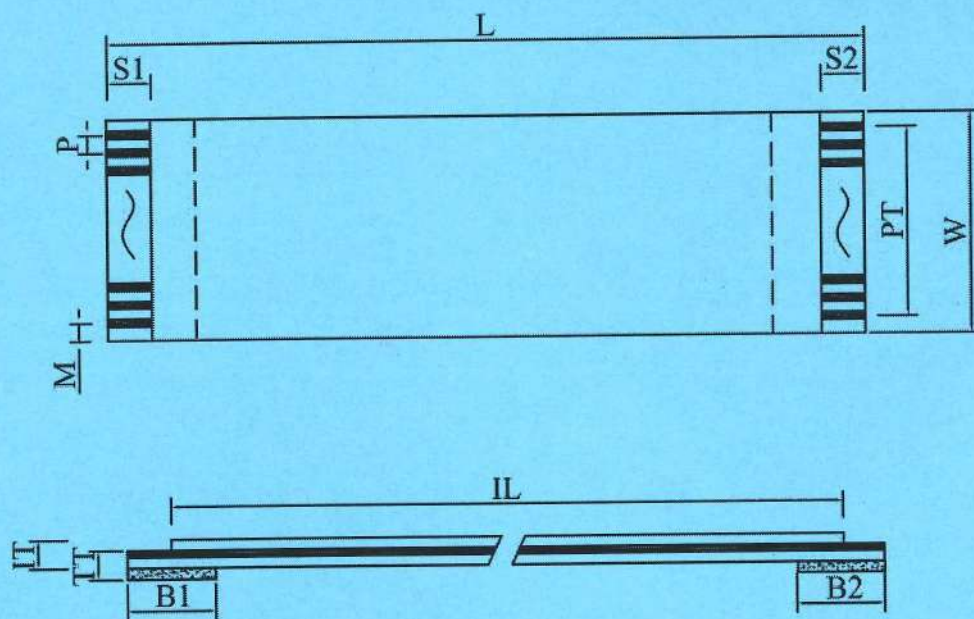

FFC 软排线目前广泛应用于各种打印机打印头与主板之间的连接，绘图仪、扫描仪、复印机、音响、液晶电器、传真机、各种投影仪等产品的信号传输及板板连接。

FFC ソフト配線は現在、各種プリンタのプリントヘッドとマザーボード間の接続、プロッタ、スキャナー、コピー機、音響、液晶電器、ファックス、各種プロジェクターなどの製品の信号伝送及び基板接続に広く応用されている。

FFC flexible cable is currently widely used in the connection between the printer head and the main board, plotter, scanner, photocopier, audio, LCD appliances, fax machine, all kinds of DVD player and other products signal transmission and board connection.

CHUFON TECHNOLOGY CO., LTD.

淳峰實業有限公司

Samples

1、鍍錫 (Tin plating) 錫メッキ

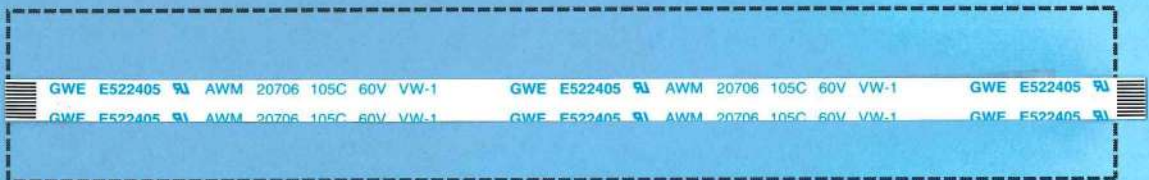
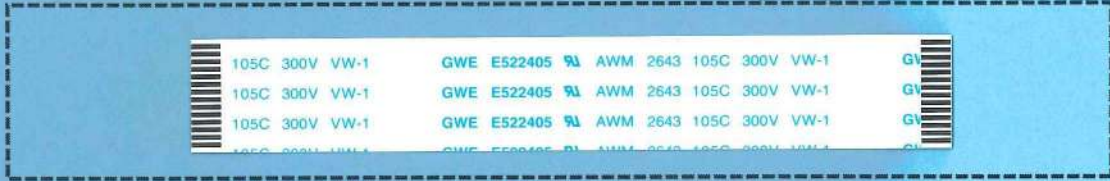

2、鍍金 (Gold Plating) 金メッキ



CHUFON TECHNOLOGY CO., LTD.

淳峰實業有限公司

FFC 特殊工序 特殊工程

FFC special process cable

一、电磁屏蔽 (EMI Shielding Cable) EMI 貼付

1、贴铝箔 (Aluminum Foil) アルミ箔貼付

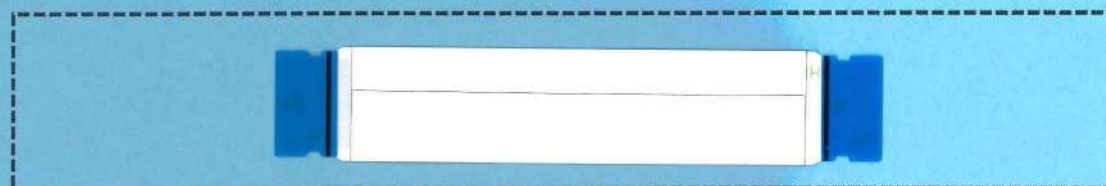
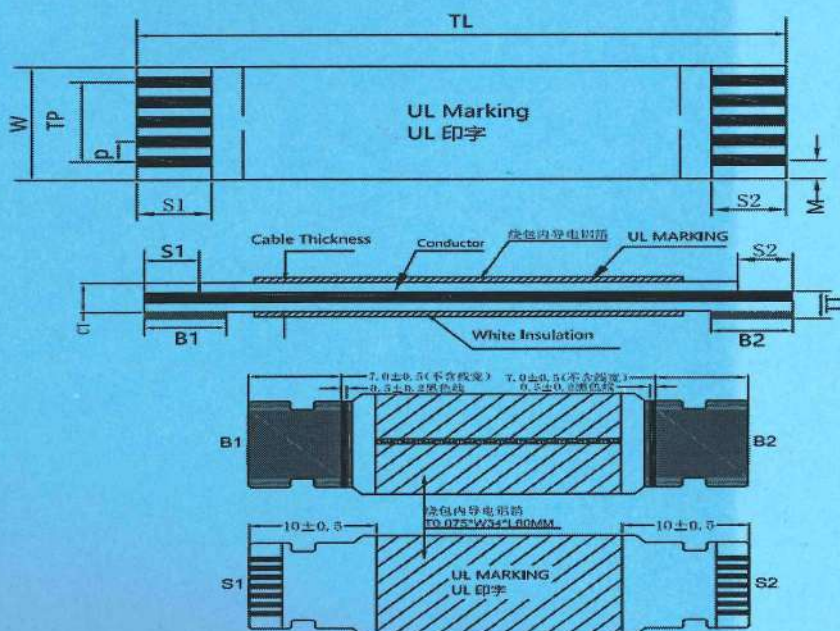

CHUFON TECHNOLOGY CO., LTD.

淳峰實業有限公司

1、貼醋酸布 (Acetate Tape) 醋酸布貼付

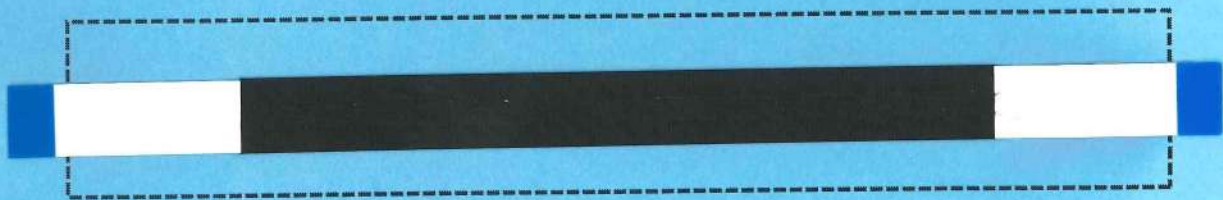
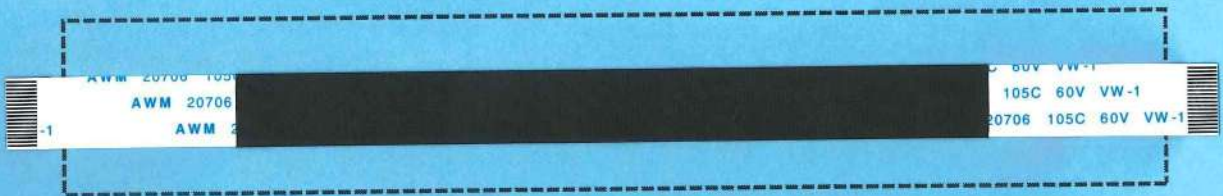
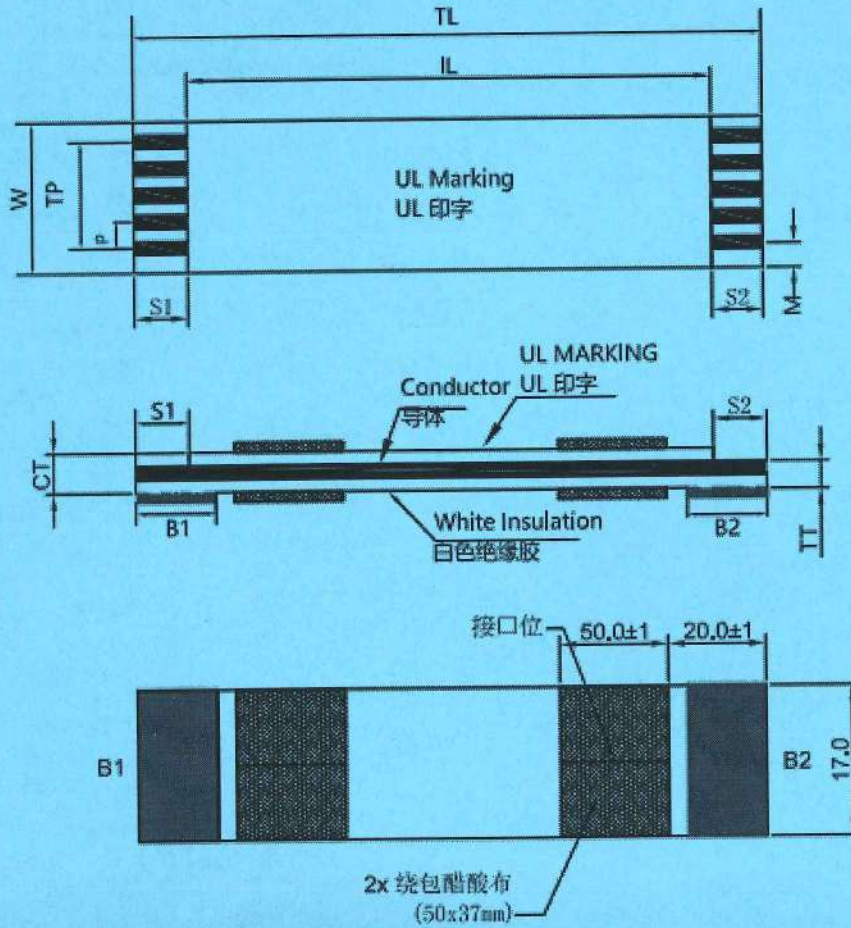

CHUFON TECHNOLOGY CO., LTD. 淳峰實業有限公司

3、贴导电布 (Conductive Fabric) 導電性布貼付

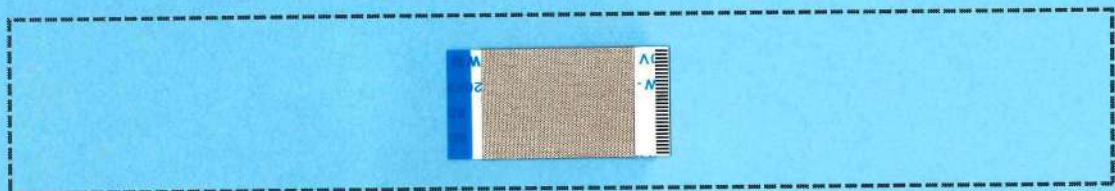
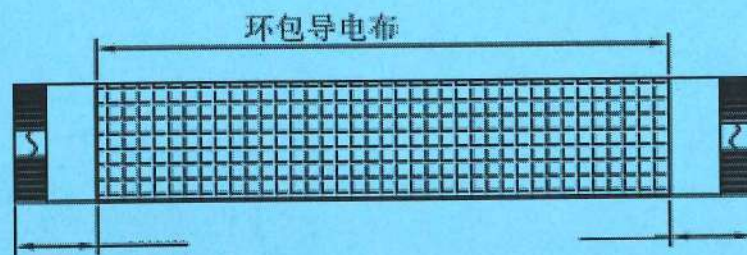
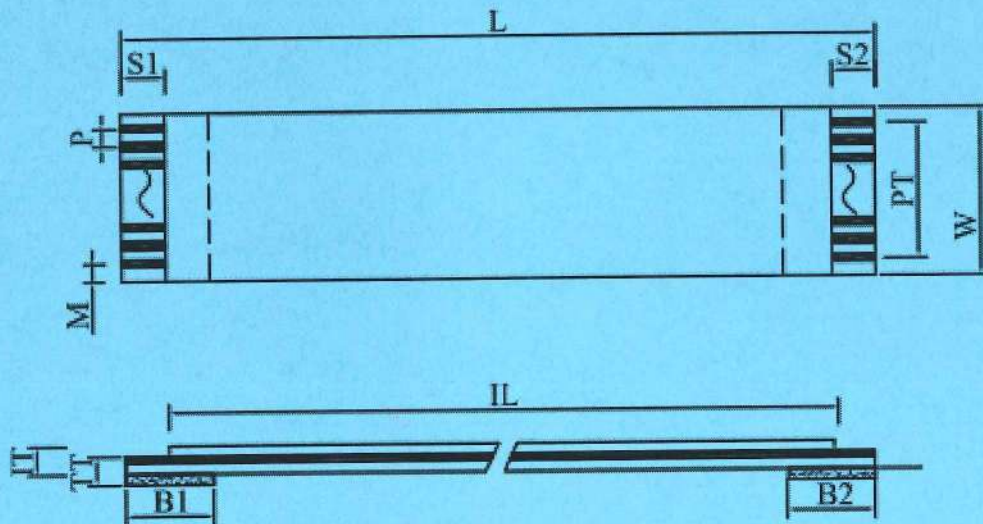

CHUFON TECHNOLOGY CO., LTD.

淳峰實業有限公司

4、貼高温膠帶、泡棉加工 (Insulated Tape and Foam Tape) 高温テープ貼付、発泡綿加工

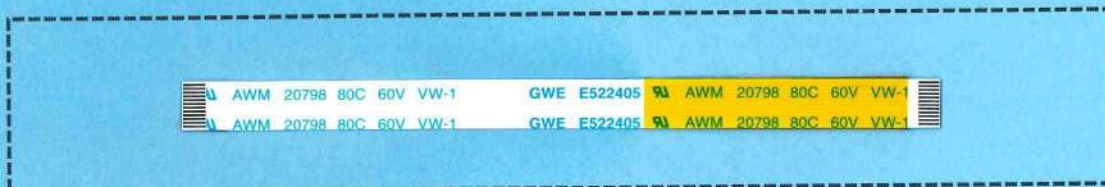
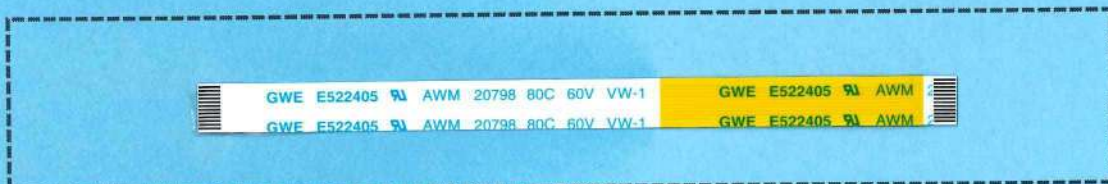

5、折线加工 (Fold) 折り曲げ加工

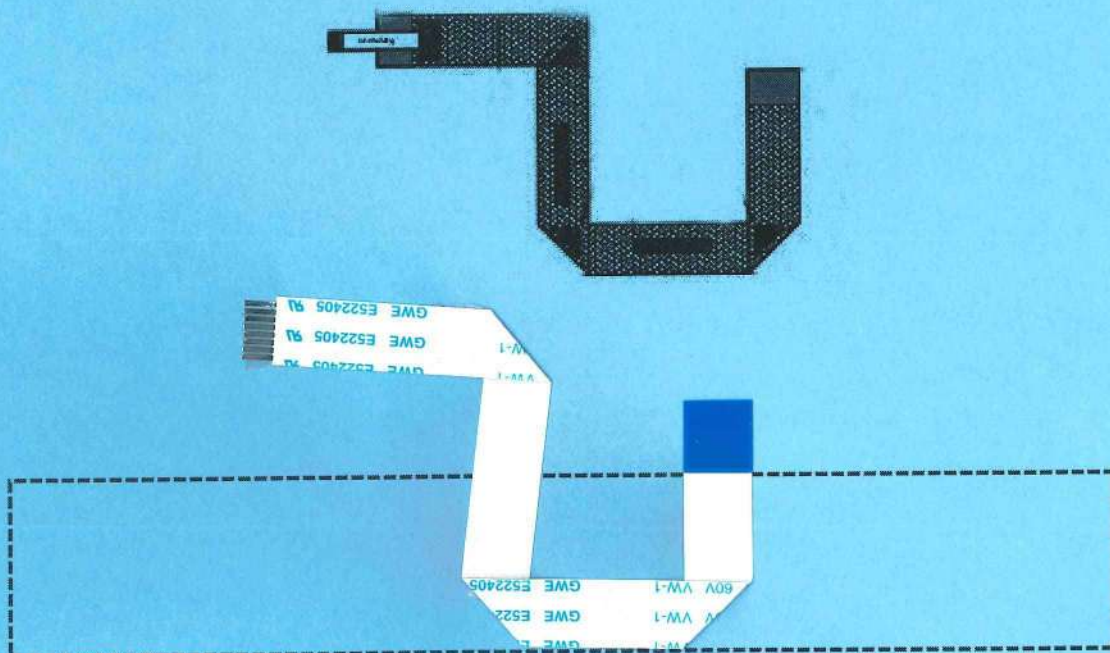

CHUFON TECHNOLOGY CO., LTD. 淳峰實業有限公司

6、冲边（Punching Edge）外形プレス

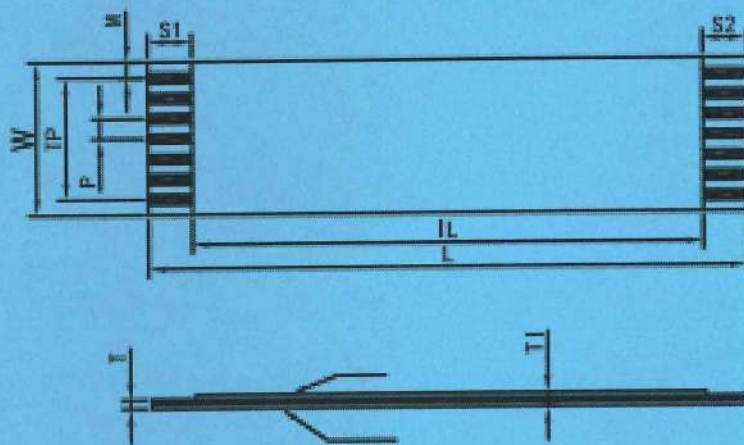

CHUFON TECHNOLOGY CO., LTD. 淳峰實業有限公司

汽车大电流导线 (High current cable) 自動車の大電流導線

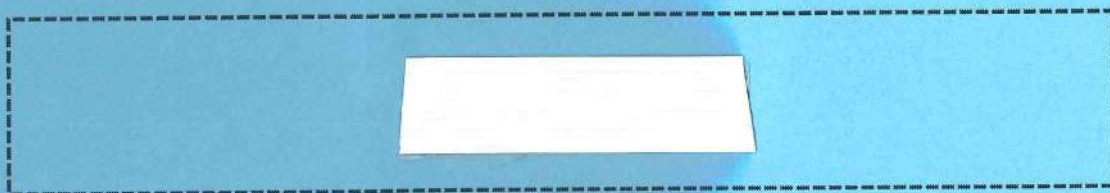
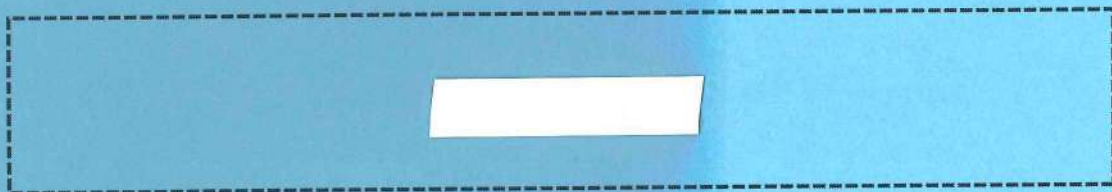
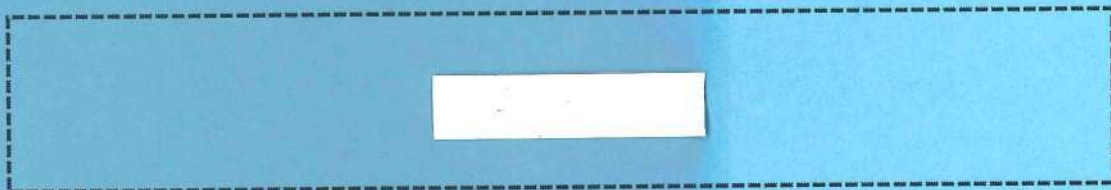
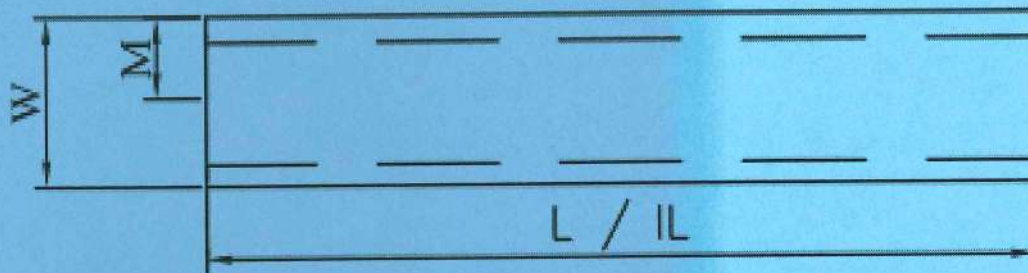

DF9 Cable assembly

Sample

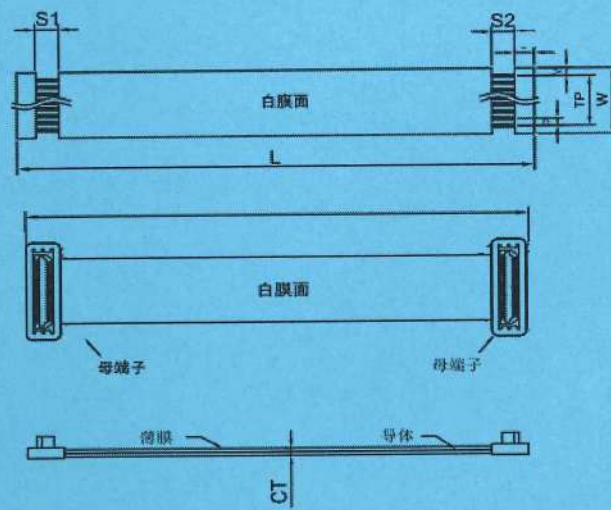

CHUFON TECHNOLOGY CO., LTD.
淳峰實業有限公司

RFC CABLE

RFC 排线

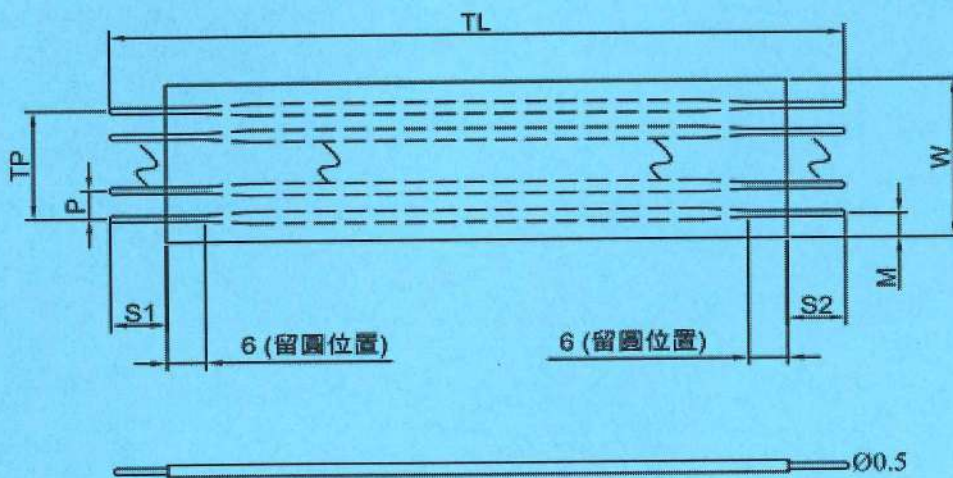

应用于各类 PLC 控制器、医疗器内、航空航天器械内、彩色 B 超超声波产品，工业电源电气、伺服步进电机，太阳能控制器、火灾探测器、红外线光谱色温测试仪、多功能负荷状态分析仪，以及综合电力监控分析仪。工业仪器以及各类产品 PCB 板之间的焊接连接应用最多。产品电流可以通过 2A~6A。

各種 PLC コントローラ、医療機器内、航空宇宙機器内、カラー超音波製品、工業電源電気、サーボステッピングモーター、太陽エネルギーコントローラ、火災検出器、赤外線スペクトル色温度測定器、多機能負荷状態分析器、および総合電力監視分析器に応用されている。工業機器及び各種製品の PCB 板間の半田接続は最も多く応用されている。製品電流は 2A~6A を流れることができる。

All kinds of PLC controller, medical equipment, aerospace equipment, ultrasonic products, industrial power supply electric generator, solar controller, servo, fire detector, infrared spectral color temperature tester, multi-function load state analyzer, integrated power monitoring analyzer, industrial instrumentation and all kinds of PCB welding connection between applications. The product current can pass 2A~6A.

CHUFON TECHNOLOGY CO., LTD.
淳峰實業有限公司

Sample

Nomex

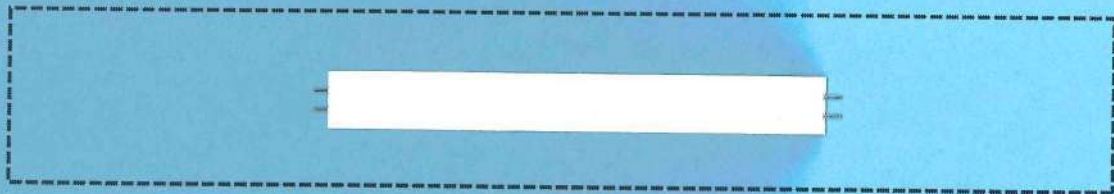

PET

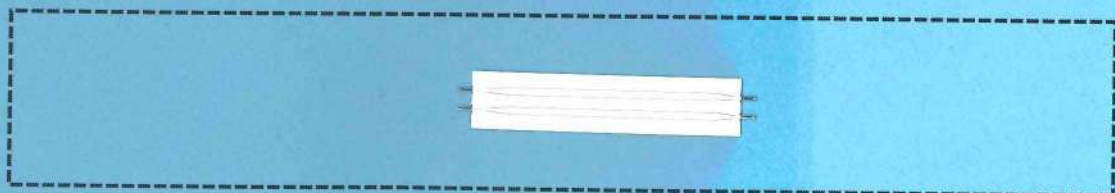

CHUFON TECHNOLOGY CO., LTD.
淳峰實業有限公司



PI

